



 **parsteel**

RIVET SHELVINGS

RIVET SHELVINGS



Parsteel distributes the highest quality, full-line assortment of material handling and storage equipment in the industry. Our products combine years of proven engineering with the latest technology and supply chain practices. With manufacturing plants strategically located throughout the world, we can provide the right solution for every storage application. By maintaining a strong economic focus along with our commitment to the most stringent quality standards, Parsteel is your complete global storage solution.

BOLTLESS RIVET SHELVING



One of the most popular storage solutions that we offer is our Boltless Rivet Shelving. With a wide range of sizes, capacities and design layout options, it is perfect for both warehouse and office applications. Rivet Shelving is one of the most versatile storage solutions within our industry. With a wide variety of sizes and capacities, standard components can quickly make the most complex projects a custom fit. For higher density applications, Single Rivet Shelving offers a more efficient use of storage space. With Single Rivet Beams measuring only 1" thick, they provide the maximum usable clearance possible between shelves. Sections are designed with Double Rivet Beams for the top and bottom levels and use Single Rivet Beams for the intermediate. Since diagonal braces are not required with Rivet Shelving, products can be accessed from all sides of the section.

ADVANTAGES

- Our Rivet Shelving has been designed for handling larger volume items both efficiently and economically. Sections can be as large as 96" wide minimizing the number of post obstructions and accommodating an array of load sizes within the same unit. Their depth can be as great as 48" and since there are no side or back braces, sections can easily be entered from all directions. Rivet shelving is a very simple and versatile system, easy to assemble, all you need to put it together is a rubber mallet

COMPONENTS



DOUBLE RIVET



Rivet Shelving has rapidly become one of the most versatile storage solutions within our industry. With a wide variety of sizes and capacities, standard components can quickly make the most of complex projects a custom fit. Atlas Mega Steel's Double Rivet Shelving has been designed for handling larger volume items both efficiently and economically. Sections can be as large as 96" wide minimizing the number of post and obstructions and accommodating an array of load sizes within the same unit. Their depth can be as great as 48" and since there are no side or back braces, sections can easily be entered from all directions. For sections 72" or smaller, each level has a 1,000 lbs capacity with certain sizes requiring one Center Support per level. Sections 96" long have an 800 lbs capacity per level and require two Center Supports.

Double Rivet Beams			
in	mm	in	mm
12"	305	42"	1067
15"	381	48"	1220
18"	457	60"	1524
24"	610	72"	1829
30"	762	96"	2438
36"	914	96" CH	2438

Standard 96" Long Beams have a Channel Design
Additional Sizes Available Upon Request



TECHNICAL DETAILS

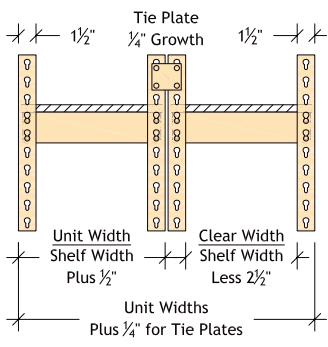
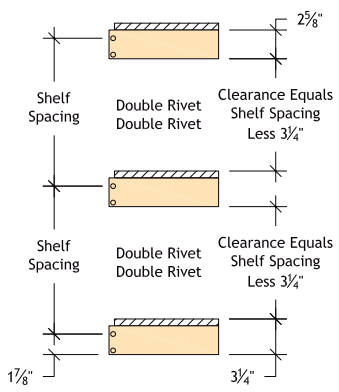

EXAMPLE OF SECTION GROWTH

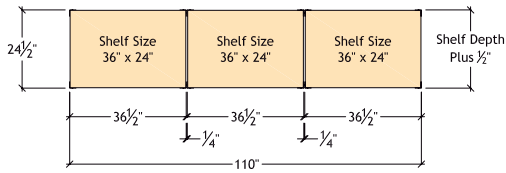

Shelf levels are adjustable on 1-1/2" centers. Sections over 12' high have posts 1-7/8" x 1-7/8". Easy assembly with only a rubber mallet.

SINGLE RIVET



For higher density applications, Atlas Mega Steel's Single Rivet Shelving offers a more efficient use of storage space. With Single Rivet Beams measuring only 1" thick, they provide the maximum usable clearance possible between shelves. Sections are designed with Double Rivet Beams for the top and bottom levels and use

Single Rivet Beams for the intermediate. Since diagonal braces are not required with Rivet Shelving, products can be accessed from all sides of the section. Single Rivet Sections can be as large as 48" long and 48" deep, helping to provide an economic solution to the most complex

layouts. For sections 24" deep or smaller, Single Rivet Levels only have beams on the front and back to adequately support the decking. Sections that are greater than 24" deep require beams on all four sides. Shelves are adjustable on 1/2" centers and are easily assembled with only a rubber mallet.

Single Rivet Beams			
in	mm	in	mm
12"	305	30"	762
15"	381	36"	914
18"	457	42"	1067
24"	610	48"	1220

Additional sizes available upon request.
Sections 24" deep and smaller have beams on front & back only.



TECHNICAL DETAILS

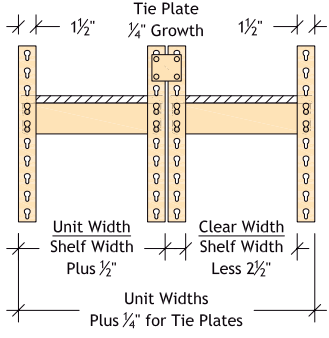
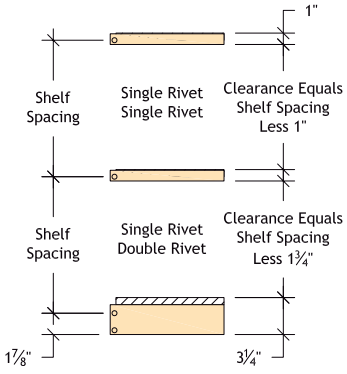

EXAMPLE OF SECTION GROWTH

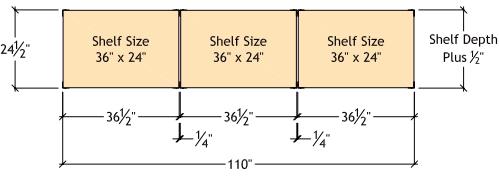

Single Rivet sections 10' or higher require a minimum of 3 Double Rivet levels for rigidity (can include top and bottom).
Sections over 12' high have posts 1-7/8" x 1-7/8".



APPLICATIONS



For hand stacked light to medium duty applications,
ideal for warehouse, office and home storage.



PALLET RACKS

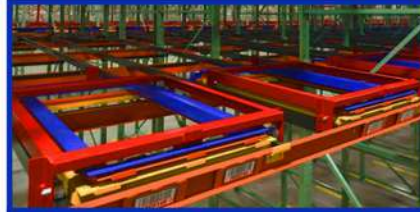

PUSH-BACKS

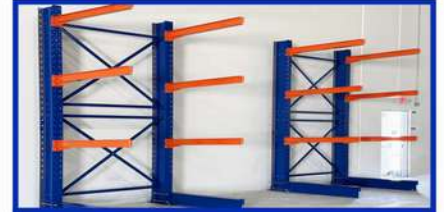

CANTILEVERS



DRIVE-IN / THRU



PALLET JACK



RIVET SHELVINGS



STEEL SHELVINGS



MEZZANINES



PALLETS & CARTON FLOW



CONTACT US

 305-821-3000

 www.parsteel.com

 7527 W 20TH AVE Hialeah,
FL 33014, United States